

Серия «Папка дошкольника»

Ребусы, игры, головоломки

Задания на развитие логики, внимания

Для
детей
4-6
лет

А ША
ЛЮ



Солнечные
ступеньки®

Расшифруй и напиши имена детей.

НЯ

--	--	--	--



ША
ДЮ

--	--	--	--	--	--

СЯ

--	--	--	--



ВА

--	--	--	--



РА

--	--	--	--



ЛЮША

--	--	--	--	--	--

КА

--	--	--	--

РЯ

--	--	--	--

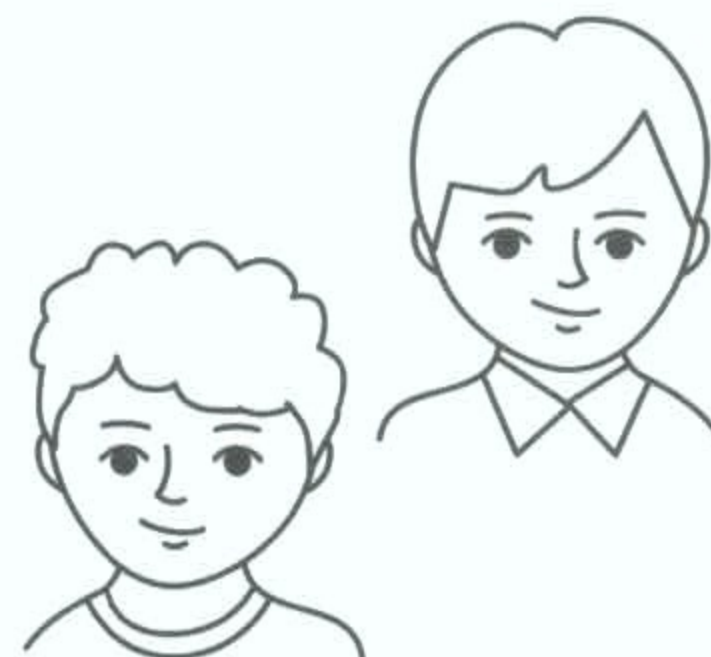

Вставь нужную букву и прочитай слово.



$\frac{\text{Т}}{\text{Р}}$ ОЗА

--	--	--	--

$\frac{\text{А}}{\text{М}}$ ИСТ

--	--	--	--

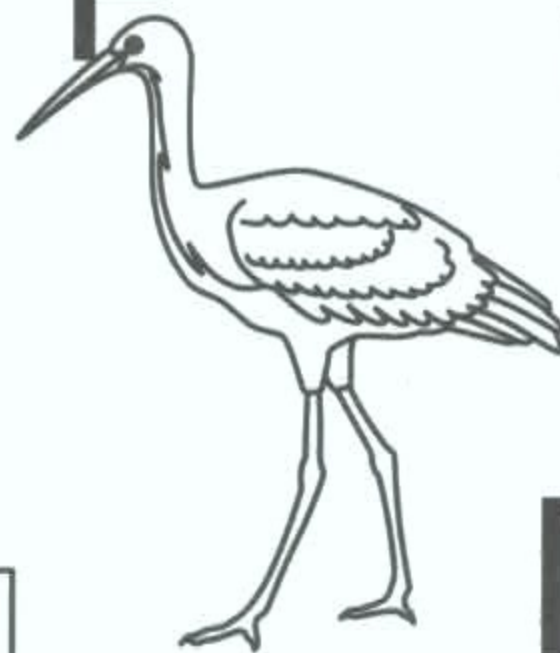

$\frac{\text{П}}{\text{Р}}$ ИЛА

--	--	--	--

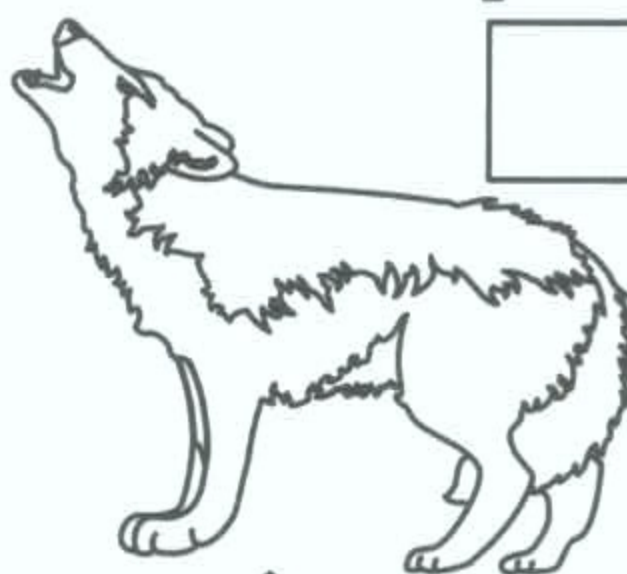
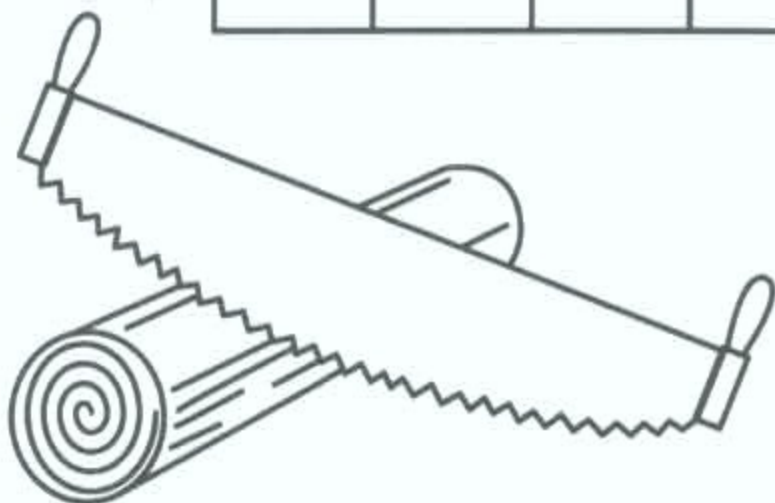

ВО $\frac{\text{Н}}{\text{Л}}$ К

--	--	--	--



ДО $\frac{\text{О}}{\text{И}}$ М

--	--	--

$\frac{\text{И}}{\text{У}}$ КУТ

--	--	--

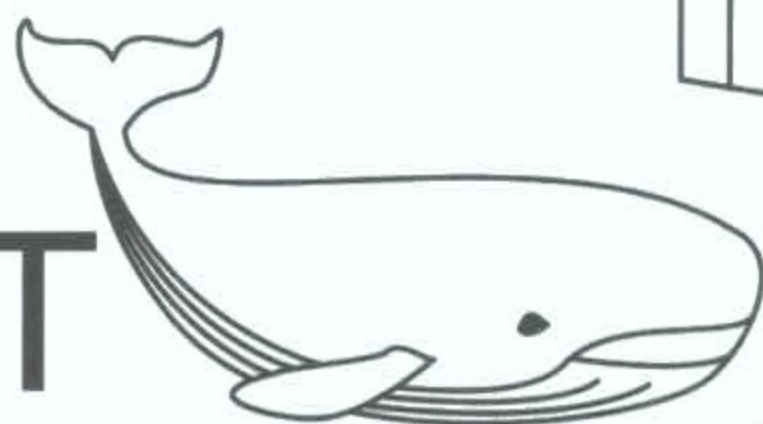

СТ $\frac{\text{И}}{\text{У}}$ Л

--	--	--	--

Разгадай ребусы.

Ш

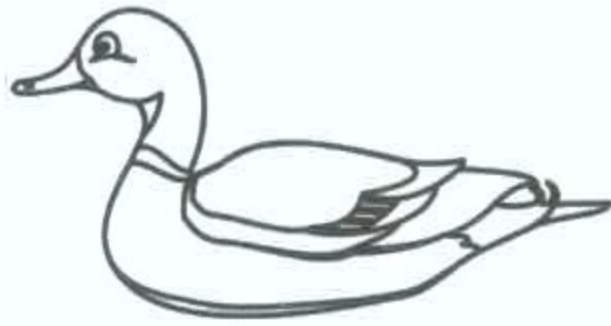

--	--	--	--	--



Ф

--	--	--	--

Э



--	--	--	--	--

100 л

--	--	--	--

Г



--	--	--	--	--

Б



--	--	--	--

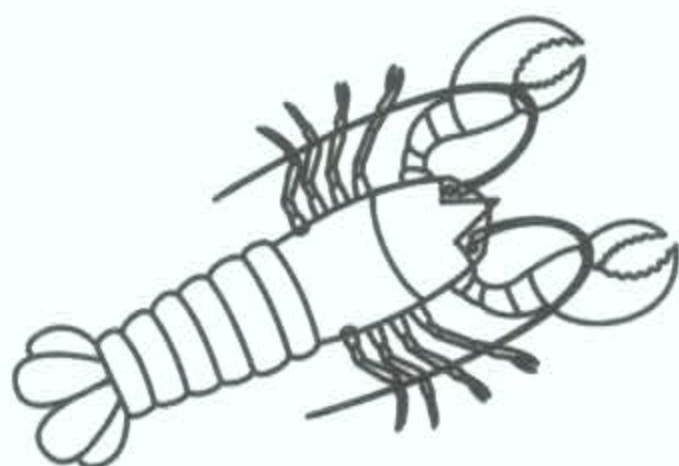

ЕТА

--	--	--	--	--	--

Замени значки буквами и прочитай слова.

Н З И А О К Т М Д
□ ○ ▤ △ ∩ × + * ^

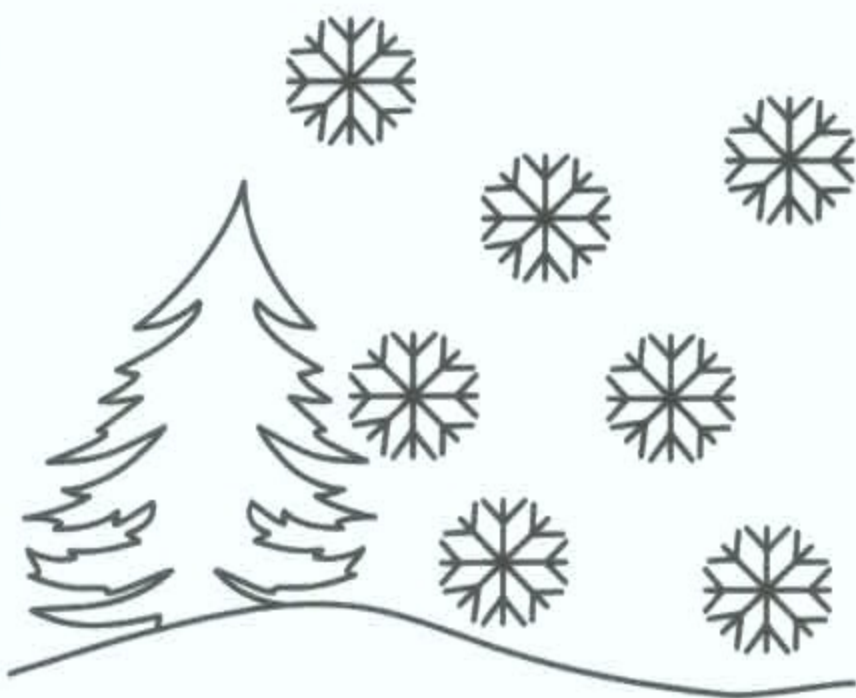

○ ▤ * △

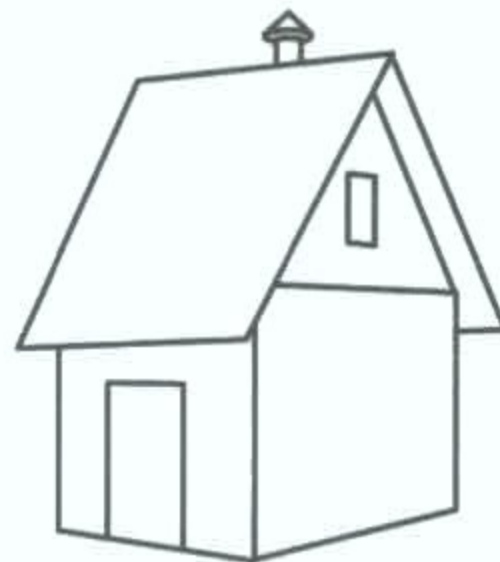

^ ∩ *



× ∩ +

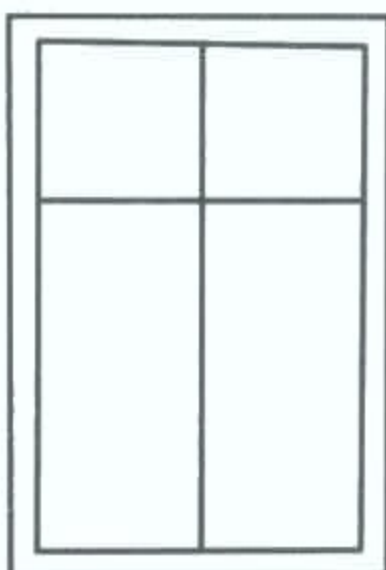

∩ × □ ∩

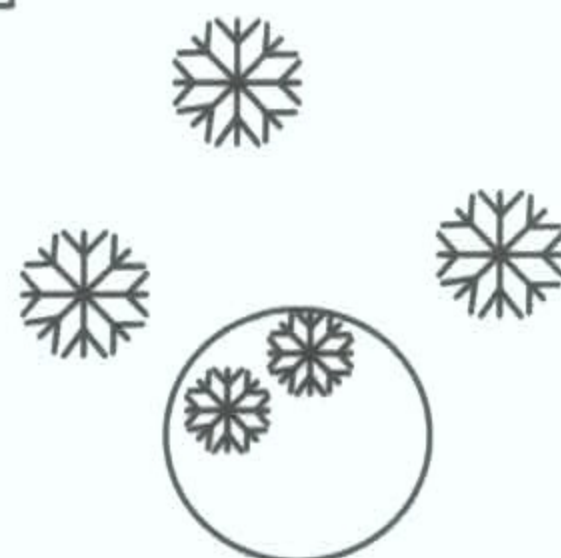

× ∩ * ∩ ×

Расшифруй ребусы.

~~Л~~

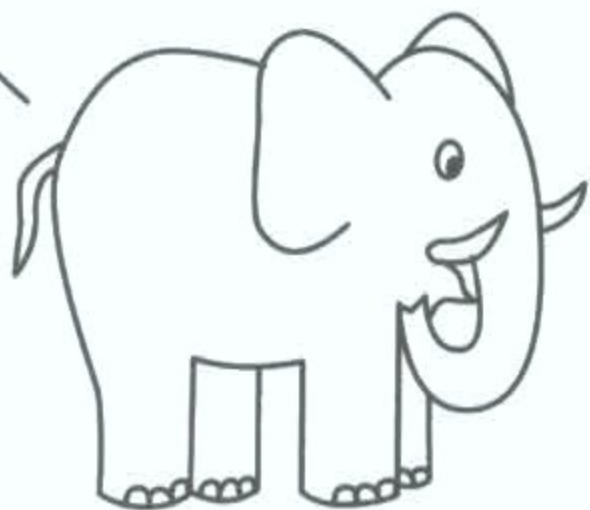

--	--	--

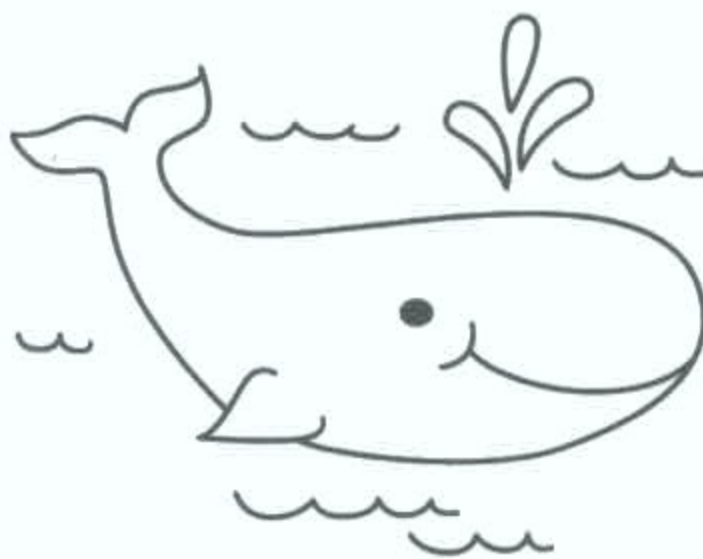

--	--	--	--	--	--



--	--	--

Б



--	--	--	--	--	--

К



--	--	--	--



КА

--	--	--	--	--	--	--	--

Расставь числа по порядку и прочитай стишок. Нарисуй картинку.

1 Я	3 РО	5 НЕ	2 МО	4 ЗА	7 ЮСЬ	6 БО
8 Я	10 НИМ	12 КО	9 С	11 КРЕП	13 ПО	15 ЖУСЬ

14
ДРУ

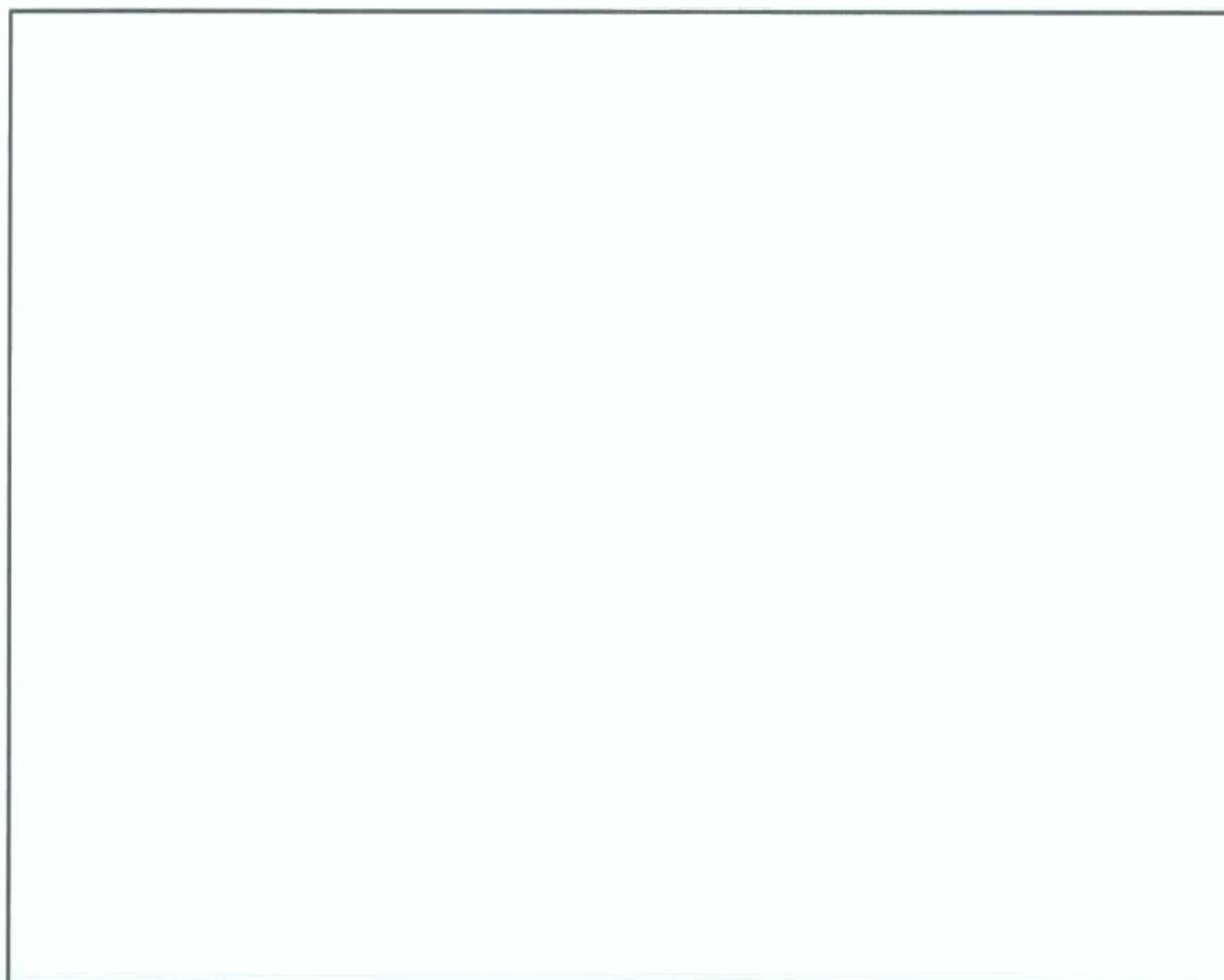

Разгадай ребусы.

РА



--	--	--	--	--	--	--

40 а

--	--	--	--	--	--	--

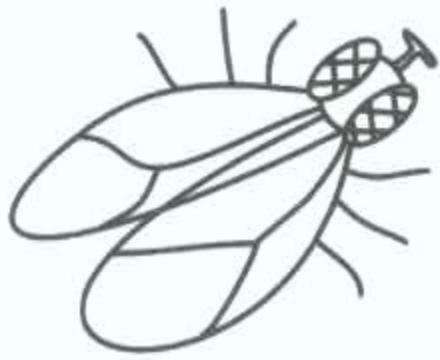

~~К~~
~~Х~~

--	--	--	--	--



~~Ю~~
~~У~~

--	--	--

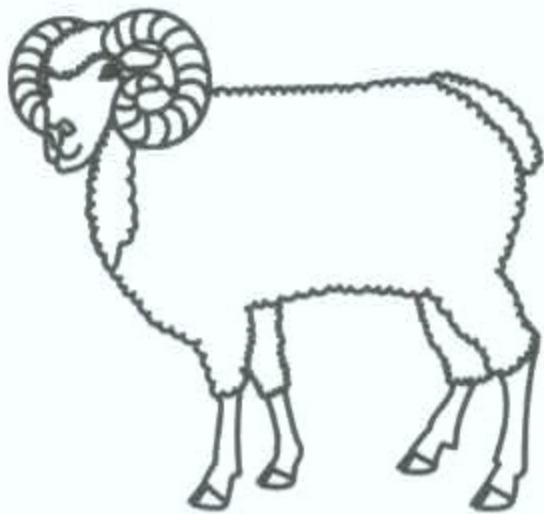

КА

--	--	--	--	--	--	--



Б

--	--	--	--	--	--

Прочитай название игрушек по первым буквам картинок.

--	--	--



--	--	--	--	--

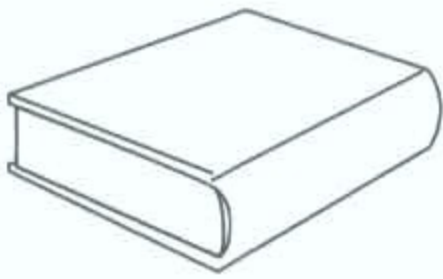

--	--	--	--	--	--	--	--	--	--	--

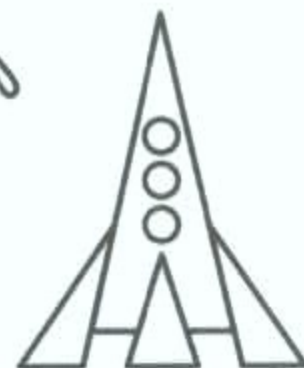
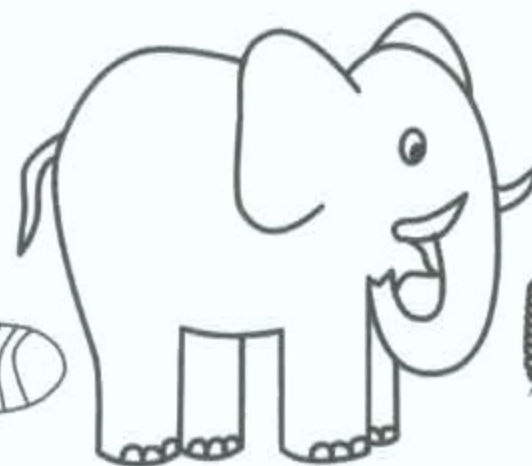

Разгадай ребусы.



--	--	--	--	--	--



--	--	--	--	--



--	--	--	--	--



--	--	--	--	--	--



--	--	--	--	--



--	--	--	--	--

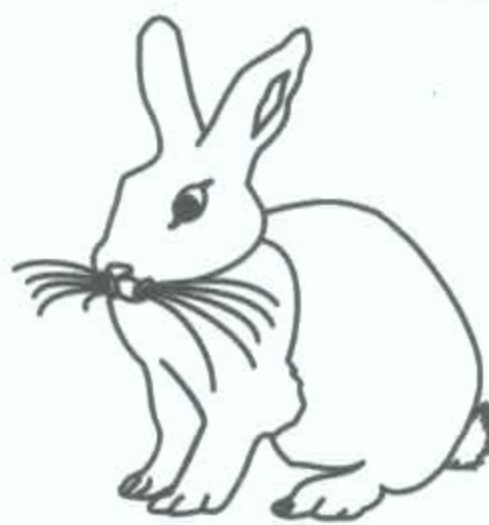

--	--	--	--

Разгадай музыкальные ребусы.

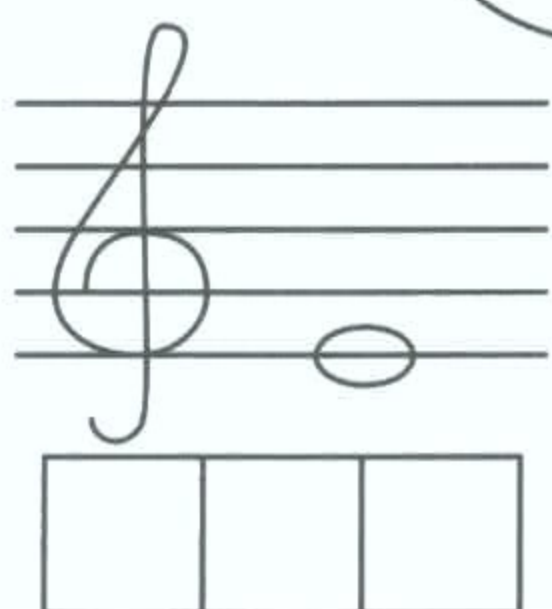
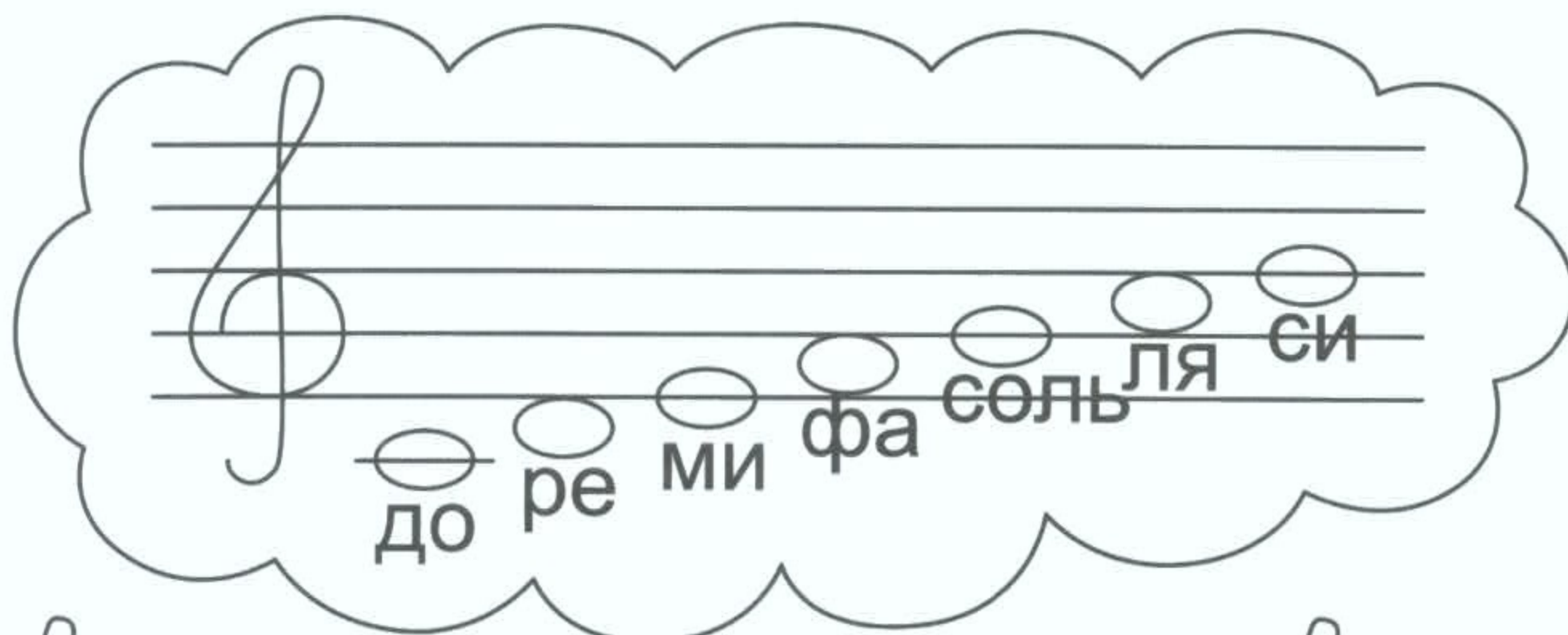

Р

МО

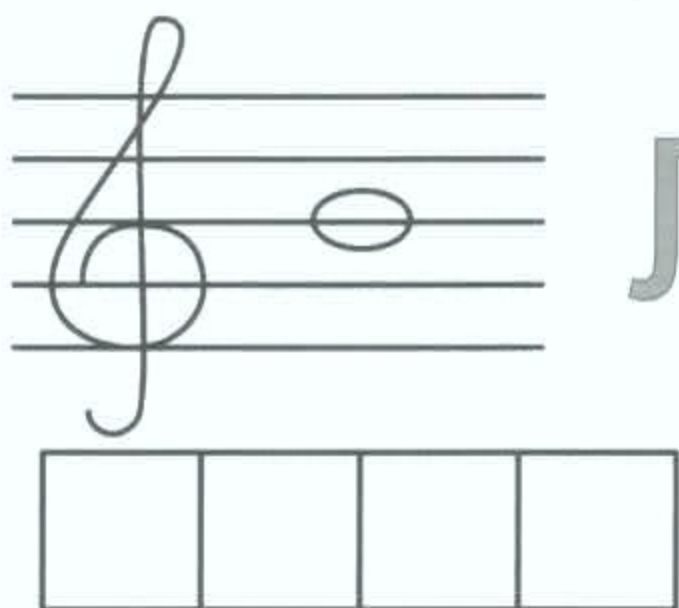
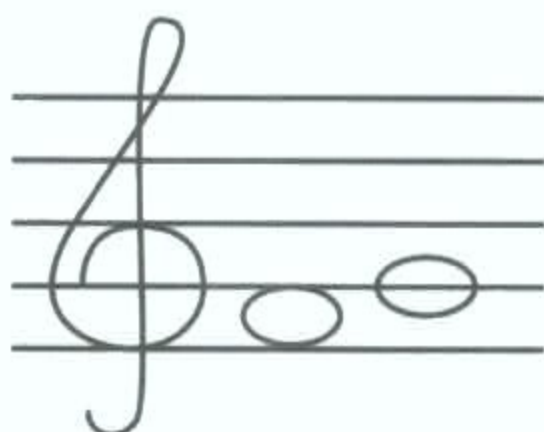
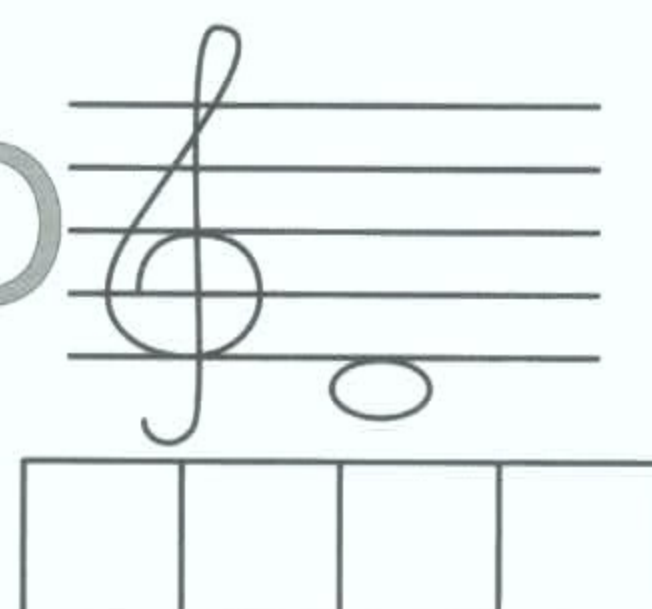

ЛА

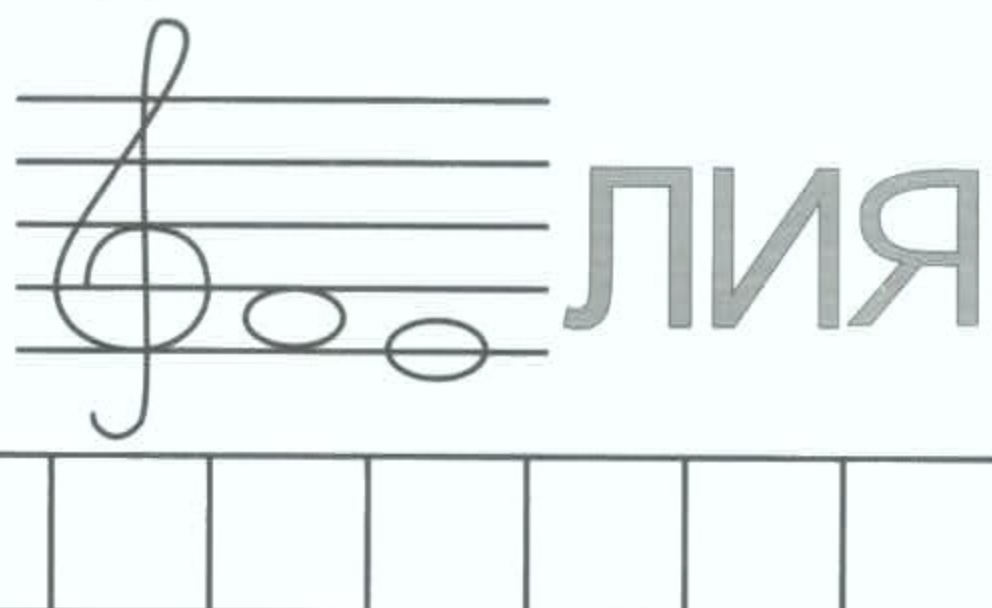

ЛИЯ

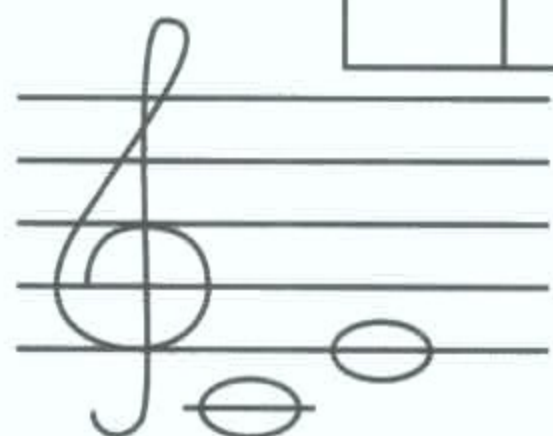

НО

Расшифруй слова. Каждой букве соответствует результат арифметического действия.

М	$8 - 6 =$	
---	-----------	--

Н	$4 + 5 =$	
---	-----------	--

Р	$5 - 1 =$	
---	-----------	--

Л	$4 + 1 =$	
---	-----------	--

Н	$3 + 3 =$	
---	-----------	--

О	$10 - 2 =$	
---	------------	--

А	$1 + 2 =$	
---	-----------	--

И	$10 - 4 =$	
---	------------	--

И	$4 + 1 =$	
---	-----------	--

М	$8 - 1 =$	
---	-----------	--

А	$2 + 1 =$	
---	-----------	--

Ы	$9 + 1 =$	
---	-----------	--

2	3	4	5	6	3

5	6	7	8	9	10

О	$10 - 8 =$	
---	------------	--

С	$5 - 2 =$	
---	-----------	--

М	$8 - 7 =$	
---	-----------	--

Т	$8 - 4 =$	
---	-----------	--

1	2	3	4

Расшифруй ребусы.



Л
~~Д~~

--	--	--	--	--	--



--	--	--	--

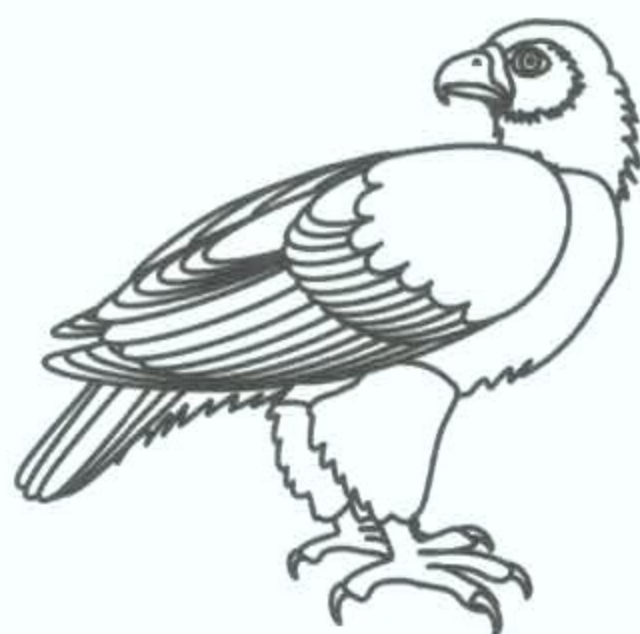

С
~~Р~~

--	--	--	--

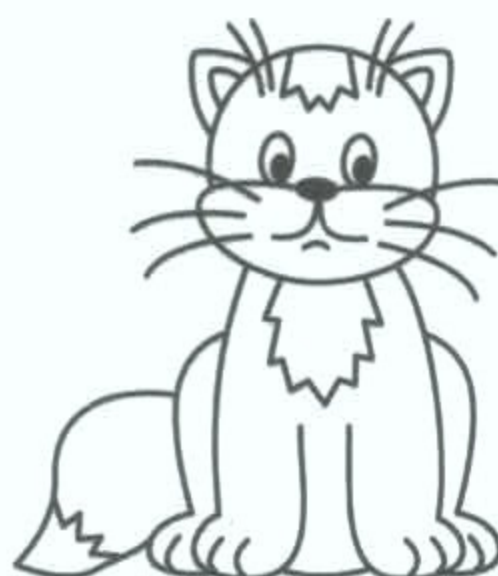

ЁЛ

--	--	--	--	--	--

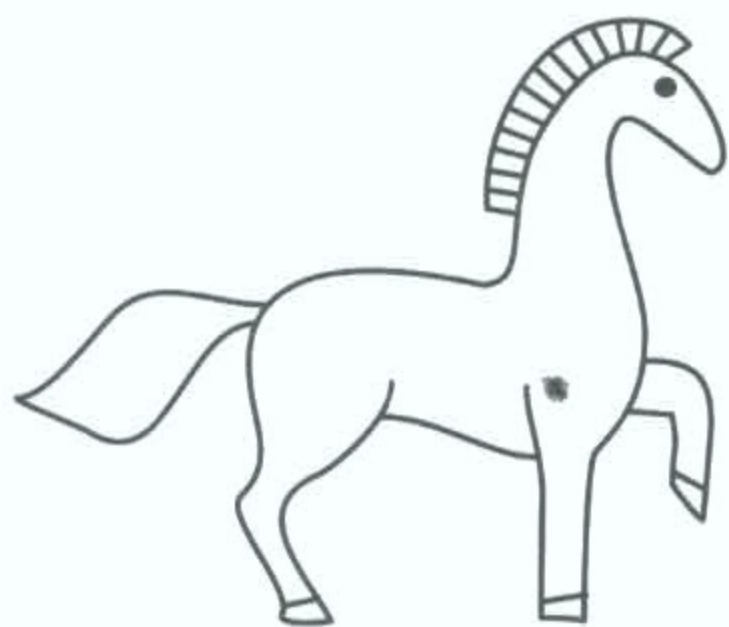

КИ

--	--	--	--	--	--

ИГ



~~Ж~~

--	--	--	--

Расшифруй ребусы.

ка
т

пе
л



--	--	--	--	--

--	--	--	--	--

ба
н

па
ма

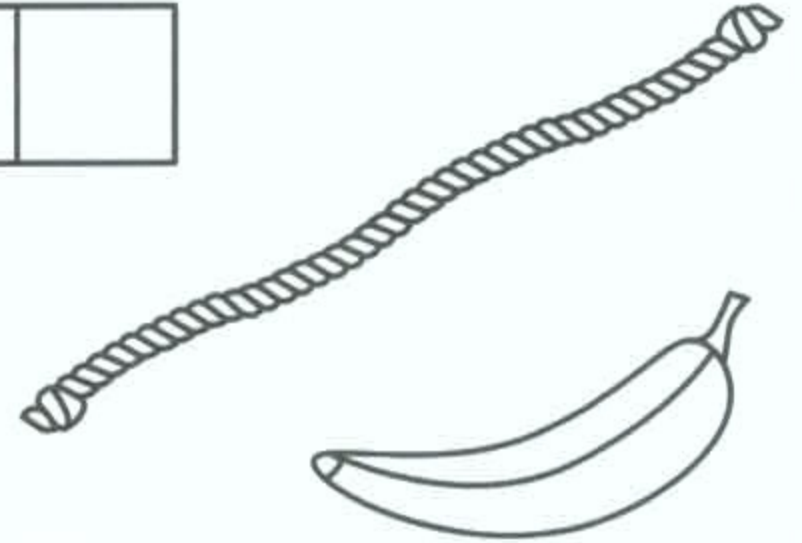

--	--	--	--	--

--	--	--	--	--	--



ТОК
пи



--	--	--	--	--	--	--

ка
сед



да

--	--	--	--	--	--	--

тка

--	--	--	--

ка
ход

--	--	--	--	--	--	--

--	--	--	--	--

рота

рба

--	--	--	--	--

--	--	--	--	--	--

Расшифруй и прочитай пословицы.

1
ДЕ

5
ПО

7
ХЕ

2
ЛУ

3
ВРЕ

6
ТЕ

8
ЧАС

4
МЯ

--	--	--	--

—

--	--	--	--	--	--

,

--	--	--	--	--	--

—

--	--	--

.

1
НЕ

3
ШИ

6
КОМ

2
СПЕ

4
Я

5
ЗЫ

7
ТО

11
ЛОМ

10
ДЕ

9
ПИСЬ

8
РО

--	--

--	--	--	--	--	--

--	--	--	--	--	--	--	--

,

--	--	--	--	--	--	--	--

--	--	--	--	--

.

Расшифруй названия городов и рек.

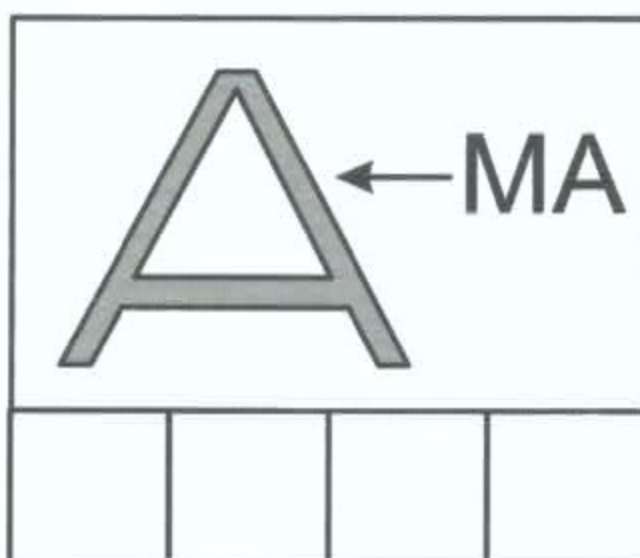
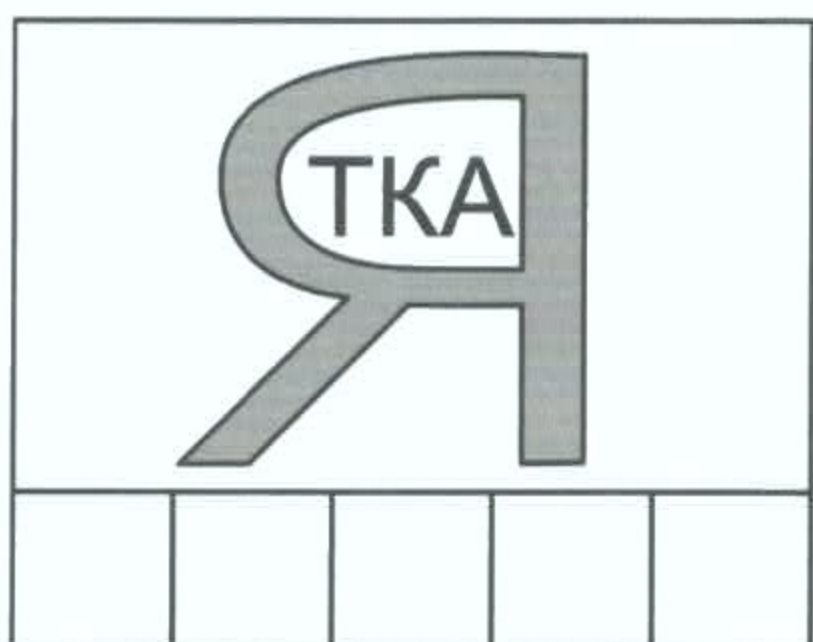
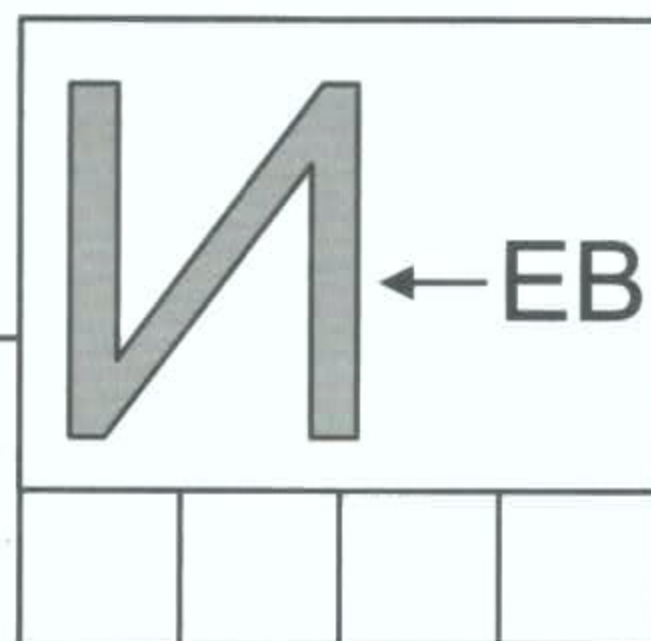
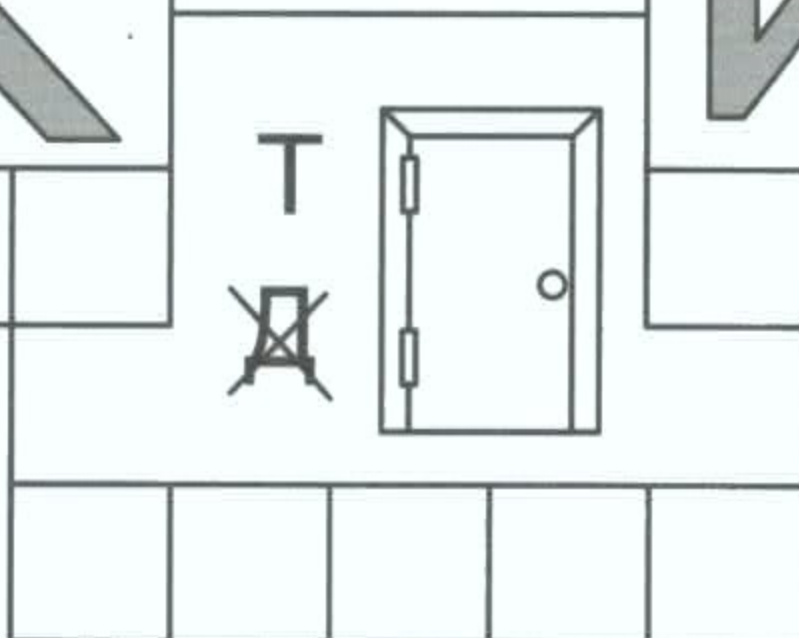
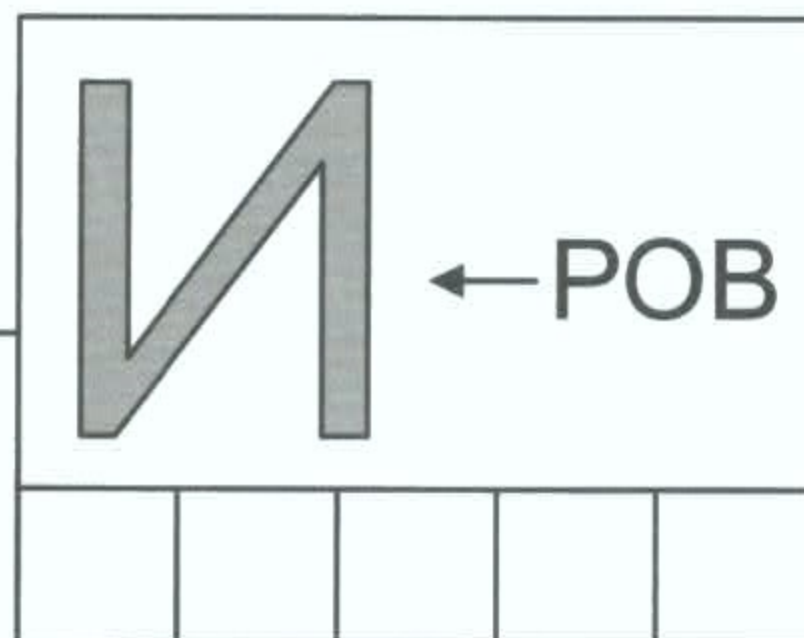
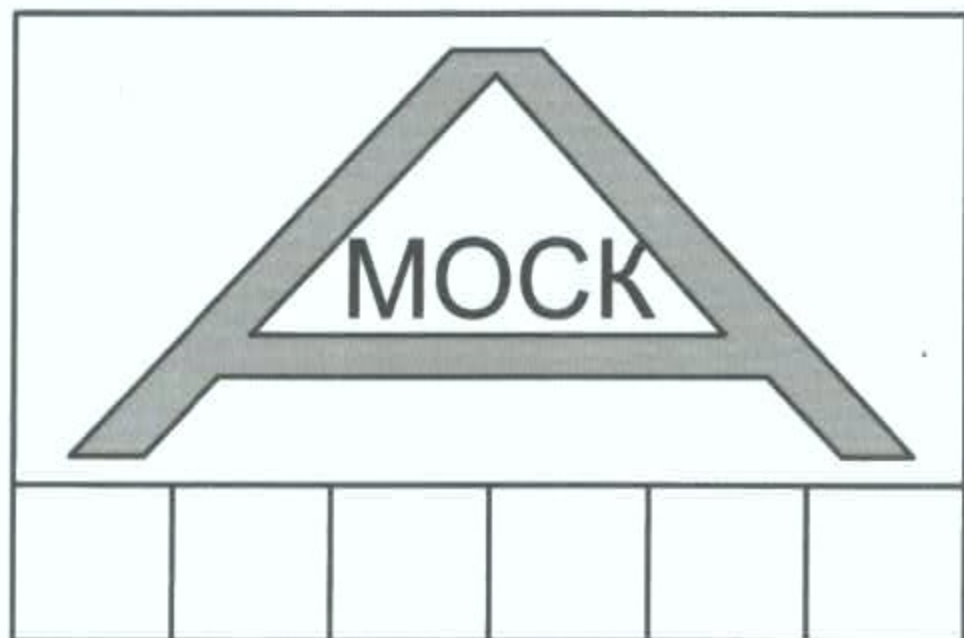

Ответы:

- 1 стр. Ваня, Надюша, Вася, Вова, Вера, Валюша, Вика, Варя.
- 2 стр. Роза, аист, пила, волк. дом, кит, стул.
- 3 стр. Шутка, шарф, экран, стол, гроза, бусы, ракета.
- 4 стр. Зима, дом, кот, окно, комок.
- 5 стр. Сон, китель, вол, бочки, крот, кувшинка.
- 6 стр. Я мороза не боюсь, я с ним крепко подружусь.
- 7 стр. Радуга, сорока, мука, люк, баранка, столб.
- 8 стр. Мяч, кубик, конструктор.
- 9 стр. Вопрос, дрова, ведро, слово, ветка, замок, заяц.
- 10 стр. Мир, море, фасоль, сила, фамилия, домино.
- 11 стр. Марина, лимоны, мост.
- 12 стр. Булка, зубы, осёл, котёл, коньки, игра.
- 13 стр. Канат, пенал, банан, панама, напиток, насадка, вода, находка, ветка, верба, ворота.
- 14 стр. Делу - время, потехе - час.
Не спеши языком, торопись делом.
- 15 стр. Москва, Тверь, Киров, Вологда, Воронеж, Киев, Вятка, Кама, Волга.

